



POF 1262-A  
(INDIGENOUS  
SUPPLIES)

Government of Pakistan  
PAKISTAN ORDNANCE FACTORIES  
TENDER ENQUIRY

To M/s

---

---

---

---

Dear Sirs,

Reference : TENDER ENQUIRY NO. 0042/LP/HVN/54

DATED 05-APR-24

You are requested to submit quotations for the item(s) noted in the Schedule to the Tender. Please note the following instructions for filling the tender:-

**1. SUBMISSION OF TENDER**

- 1.1 Tenders will be opened at **10:30 hours** on **07-MAY-24** at Bid Centre adjacent to Rabita Hall, POF Wah Cantt. Quotation must be submitted electronically on [www.ebidding.pof.gov.pk](http://www.ebidding.pof.gov.pk) as well as in hard form (duly sealed in envelope) before 30 minutes of opening time. The tender received late will not be entertained. You may witness the opening of the tender if you so desire. If a representative is deputed, he should bring a letter of authority from you.

Tender Enquiry No: 0042/LP/HVN/54

Tender to be opened on: 07-MAY-24

Address as follows:-

(www.ebidding.pof.gov.pk) BID CENTER

ADJACENT TO RABITA HALL

POFs, WAH CANTT.

**2. GENERAL INSTRUCTIONS REGARDING PREPARATION OF QUOTATIONS**

- 2.1 **For Materials**, the prices should be filled in column 5 and delivery date in column 7 of the schedule to this Tender Enquiry. As per **PPRA Rule 36(b)**, **Single Stage two envelope method** will be utilized for "Open competitive bidding." Moreover, technical & commercial evaluation of Bids will be carried out strictly as per PPRA rules and contract(s) will be awarded to the most advantageous bidder(s).

- 2.2 **For Plant and Machinery**, you are required to quote in two parts:-

**Part I "Technical Offer":** It should exclusively give technical details and literatures/brochures of the offered plant, machinery and equipment; validity date; delivery schedule; and signed undertaking given on the schedule to this Tender Enquiry. It must not indicate price, costs etc.

Cont....P-2

**Part II "Commercial Offer":** It should indicate the commercial terms e.g. price, terms of payment, mode of payment, mode of supply.

- 2.3 The quotation must remain valid for, at least 90 days from the date of opening of commercial tenders, extendable if so desired.
- 2.4 The quotation should hold good for any reduced or enhanced quantities without notice.
- 2.5 In the event of non-acceptance of offer, intimation may be given to the Tenderers on their request.
- 2.6 Conditional offers or alternative offers are likely to be ignored.
- 2.7 Quotations should be based on:-

F.O.R. station of dispatch basis, i.e. delivered free on rail, inclusive of packing and forwarding charges. The stores will be booked under Military Credit Note, to be provided by the purchaser.

and/or

Free delivery at POF's stores at **HAVELIAN**  
In this case Octroi duty, will be payable by the supplier.

- 2.8 Taxes and Duties etc. where applicable, must be shown separately, quoting references to Registration No. in cases of Sales Tax and relevant authority in the case of others. Offers without these clarifications and inclusive of Taxes and Duties may be ignored.
- 2.9 Taxes and duties levied on or after Tender opening date or on or after the date offer was signed and dispatched will be allowed to include in the offered rates.
- 2.10 "Suppliers will furnish a certificate, issued by Excise & Taxation deptt., that he has cleared all Professional Tax payable by him" offers received without this certificate will be rejected.
- 2.11 Suppliers will render necessary information regarding hazardous effects on environment, of the material/products supplied by them, in their quotations and shipping/dispatch documents.
- 2.12 If the requisite information is not furnished on the T.E forms or offer received is not conformity with the requirement of the T.E such offer shall be ignored.

**3. INSPECTION**

- 3.1 Supplies shall be subject to the inspection and acceptance by the competent inspection authority nominated by the Purchaser, who will arrange it at his own cost. Inspection facilities such as tools, test equipment, instruments etc will, however, be provided by the Suppliers in accordance with the relevant specifications.
- 3.2 Where considered necessary by the Purchaser, stores may be obtained on Warranty/Guarantee subject to inspection on receipt. Rejected stores will be removed and replaced with the acceptable stores by the Supplier at his own expense, within a specified time.

#### **4. TENDER FEE**

The tender must be accompanied by a copy of non-refundable fee by means of a crossed postal order/pay order for Rs. 500/- in favour of: **Director-Admin-POFs, Wah Cantt.** The tender fee instrument in original must be provided on day/date of tender opening in the Bid Center.

#### **4.1 TENDER SAMPLE**

Where required, offer must accompany tender sample., strictly according to the description and specification given in Tender Enquiry. Offer not accompanied by tender sample will NOT be entertained excepting the established and reputable firms who have either previously satisfactorily supplied the same or similar stores or have submitted an acceptable sample thereof against previous T.E.

#### **5. BID Security**

5.1 A copy of Bid Security should accompany the tender in shape of deposit at call receipt/Pay Order/Banker Cheque from scheduled bank drawn in favour of :-

##### **M.D-POF HAVELIAN CANTT**

5.2 Bid security instrument in original must be provided on the day/date of tender opening in the Bid Center as under:

- a. Registered/indexed firms including foreign firms - 2% of quoted value subject to the maximum ceiling of Rs. 0.5 Mn.
- b. Registered/un-indexed firms including foreign firms - 3% of quoted value subject to the maximum ceiling of Rs. 0.75 Mn.
- c. Unregistered Firms including foreign firms - 5% of quoted value subject to the maximum ceiling of Rs. 1.00 Mn.
- d. Govt organization/production units/state owned enterprises/welfare projects of Svcs HQ - Rs 0.50 M. can be waived off on request by DG(C)
- e. Bid money will be returned to unsuccessful (less first three lowest quotee firms) bidders on opening of commercial offers
- f. Bid money will be returned to successful bidders on submission of performance bond/unconditional B.G.
- g. Quotation accompanied with less bid money will be accepted on provisional basis for 10 x days after opening of bids. However the firms are bound to provide/furnish the balance bid money within 10 x days after opening of bid otherwise such quotations will be ignored or rejected
- h. Offers received without Bid Security will not be entertained.
- i. Bid money will be forfeited in case the quotation is withdrawn before the expiry of its validity date.

#### **6. ACCEPTANCE OF OFFERS**

6.1 POF may reject all bids or proposals at any time prior to the acceptance of bid(s) or proposal, but is not required to justify grounds for its rejection. POF shall incur no liability towards supplier or contractor who have submitted bids or proposals.

#### **6.2 PERFORMANCE BOND**

- (a) The successful bidders shall provide performance bond which shall not exceed 10% of contract value, in the form of Deposit At Call Receipt from a scheduled Bank; or, an un-conditional Bank Guarantee on a prescribed format. The performance Bond will be in favour of C.M.A.(POF) Wah Cantt. It will be returned on satisfactory completion of contract.
- (b) If the Supplier fails to furnish the Performance Bond within the specified time, such failure will constitute a breach of the contract and the Purchaser shall be entitled to make other arrangements for purchase of the stores at the risk and expense of the Supplier.

6.3 Performance Bond from State owned organizations may be waived off at the discretion of the Purchaser.

6.4 **FAILURE TO SUPPLY THE STORES**

All deliveries must be completed by the specified date. In case of failure to deliver the stores within the scheduled time should have arisen from "Force Majeure", which the purchaser may admit as reasonable ground for further time, he will allow such additional time as he may consider to have been required by the circumstances of the case. Otherwise, he will be entitled, at his discretion, to cancel the contract; and/or claim liquidated damages upto 2% but not less than 1% of the contract price of the items and their quantities for each and every month or part of a month, beyond the specified delivery date, during which these may not be delivered, subject to a maximum of 10% of the total contract value of the particular stores which remained unsupplied either in part or in full: or, to purchase from elsewhere, the unsupplied stores at the risk and cost of the supplier.

6.5 **PAYMENT**

Payment will be made by the CMA(POF) through crossed cheque on receipt/acceptance of stores on our prescribed bill form supported by receipt voucher on part/full supply basis.

(a) Payment of duties/Taxes including professional tax (where applicable) must be supported by proof of having paid these to concerned Govt. Taxation Deptt.

7. **SECURITY OF INFORMATION**

The tenderer and his employees must not communicate any information relating to the sale/purchase of stores under this enquiry to any person other than the manufacturer or to any press or agent not authorised in writing by POFs to receive it.

Please return the Schedule to the Tender duly signed by the specified date, along with the specifications, drawings etc. if any, enclosed herewith - even if you are unable to quote.

**WARNING** In case the firm abstain from making offers or fail to return/acknowledge the tender form by the specified date on three consecutive occasions, no further tender enquiry may be issued to them and their names would be liable to be removed from the approved list.

Yours faithfully

**BATOOL BIBI  
MANAGER P & P**

for PAKISTAN ORDNANCE FACTORIES

## PAKISTAN ORDNANCE FACTORIES

SCHEDULE TO TENDER NO. 0042/LP/HVN/5405-APR-24(1) FOR MATERIALS

(1)	(2)	(3)	(4)	(5)	(6)		(7)
Item No.	Description with Specs. etc.	Unit	Qty	Quoted Value	Price Per Unit FOR or free delivery		Delivery Date
					In Figures	In Words	
1	CUTTING DISC STATOR NO. 1 (GARNITURE) FOR REFINER, O.D: 610MM, DRAWING NO. DOE/M-I/0369 (SHEET NO. 01/04) Material Composition: Si: 1.03~1.43%, Cr: 24.25~26%, Ni: 1.04~1.49, Mn: 1.93, Fe: Rdr%. Viker Hardness: 600 (+-30)	NO	6				WITHIN 03 MONTHS
2	CUTTING DISC ROTOR NO. 2 (GARNITURE) FOR REFINER, O.D: 610MM, DRAWING NO. DOE/M-I/0369 (SHEET NO. 02/04) Material Composition: Si: 1.03~1.43%, Cr: 24.25~26%, Ni: 1.04~1.49, Mn: 1.93, Fe: Rdr%. Viker Hardness: 600 (+-30)	NO	6				WITHIN 03 MONTHS
3	CUTTING DISC ROTOR NO. 3 (GARNITURE) FOR REFINER, O.D: 610MM, DRAWING NO. DOE/M-I/0369 (SHEET NO. 03/04) Material Composition: Si: 1.03~1.43%, Cr: 24.25~26%, Ni: 1.04~1.49, Mn: 1.93, Fe: Rdr%. Viker Hardness: 600 (+-30)	NO	6				WITHIN 03 MONTHS
4	CUTTING DISC STATOR NO. 4 (GARNITURE) FOR REFINER, O.D: 610MM, DRAWING NO. DOE/M-I/0369 (SHEET NO. 04/04) Material Composition: Si: 1.03~1.43%, Cr: 24.25~26%, Ni: 1.04~1.49, Mn: 1.93, Fe: Rdr%. Viker Hardness: 600 (+-30)	NO	6				WITHIN 03 MONTHS

<b>Total Rs =</b>	
<b>+18% GST =</b>	
<b>Total value Rs =</b>	

(2) For Plant & Machinery:  
Specification:-

(3) **Special Conditions**

- Only Registered suppliers with Sales Tax & Income Tax Deptt.) who are on Active Taxpayers list of FBR are eligible to supply Goods/services to Govt. Deptts.
- Quotation must be according to our requirement, size and specification. The conditional or technically deviated offers from our terms/conditions as well as specifications shall be out rightly rejected.
- Only single option may be quoted. Offer with more than one option will be Rejected.
- Make/Model & Country of Origin must be mentioned in offer.
- Photocopy of tender fee (with amount) and bid money hiding the amount must be accompanied with technical offer to prove submission along with commercial offer. Hard copies of same will be reached in Bid centre before 30 minutes of opening of Technical Bid.
- Professional Tax certificate from Govt. of KPK may be submitted at the time of quotation/payment.
- Un registered firm will provide photocopy of 1 year bank statment with tec.offer.

## PAKISTAN ORDNANCE FACTORIES

SCHEDULE TO TENDER NO. 0042/LP/HVN/5405-APR-24

(1)	(2)	(3)	(4)	(5)	(6)		(7)
Item No.	Description with Specs. etc.	Unit	Qty	Quoted Value	Price Per Unit FOR or free delivery		Delivery Date
					In Figures	In Words	

8. In case order is placed on firm, they have to submit proof alongwith contractor bill regarding depositing of stamp duty @ 0.25% of contracted value to the concerned revenue office.
9. Tech. Literature attached with quotation must have firm's stamp on it.
10. 100% inspection of the store will be carried out by Manager QC Hvn.
11. Sales tax must be shown separately, otherwise quote rate will be considered as inclusive of sales tax and the same will be deducted from payment bills.
12. All the interested firms are required to submit the documentary evidence of their professional, technical, financial, legal, managerial competency of bid evaluation.
13. Undertaking of T.E schedule should be returned duly signed & stamped with quotation. Drawing is attached as ready reference.

**Undertaking**

Should our offer be accepted, we hereby undertake to supply the stores/render the services contracted on the basis of General Conditions of Contract embodied in Form POF 1281, and to deposit the performance bond within the prescribed time, failing which it will constitute a breach of contract, and POF will have the right to purchase the stores/services elsewhere at our risk and cost.

Place _____	Signature of the Tenderer _____
Date _____	Name _____
_____	Position _____
_____	Address _____
	Income Tax G.I.R. No _____
	Official Stamp _____

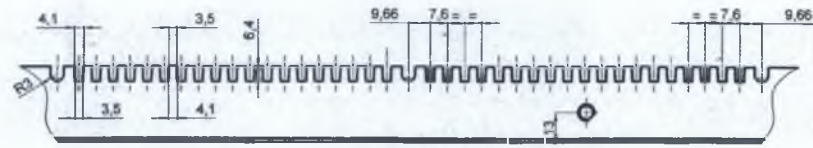
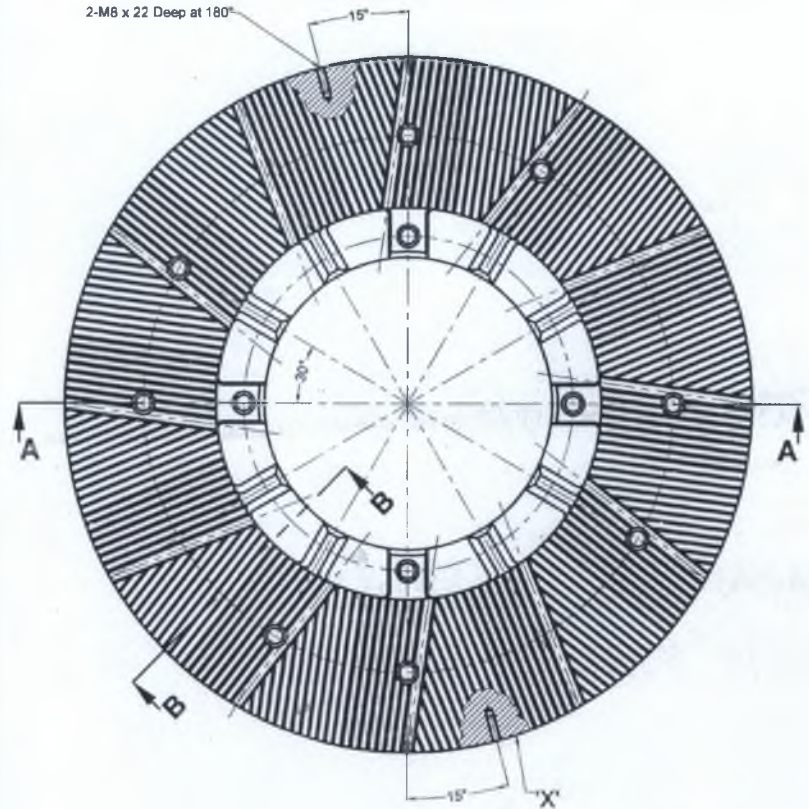

VIEW 'X'

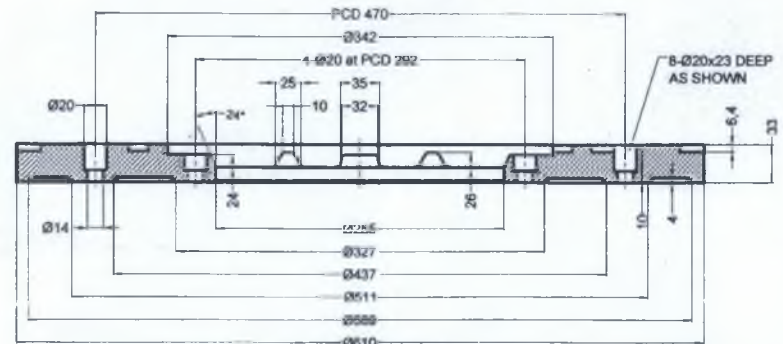

SECTION "A-A"

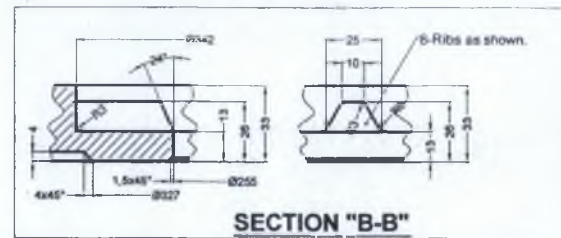

SECTION "B-B"

Note:-  
 (I) DIMENSIONS ARE IN MM  
 (II) PERMISSIBLE MACHING ALLOWANCE MAY BE ADDED

**HD & TD**  
 Vicker Hardness > 600 ±30

Material Composition Provided By User.	
Si	1.03 to 1.43 %
Ni	1.04 to 1.49 %
Cr	24.25 to 26 %
Mo	0.5 to 0.55 %
Mn	1.93 %
Tp	Rdr.

01	Refiner Disc No.Y6340-2L(STATOR-01)	01			
Sr. #	Description	Qty.	Material.	Heat Treatment	Remarks
DRAWN	Siddam & Umap Kumar C' Man / Skd				
TRACED					
CHECKED	T.O / AM- D.O.E				
APPROVED	MGR-MECH & SER				
DATE	30-08-2022				
SCALE	N.T.S		AMENDMENT		SIGR.
<b>POF HAVELIAN CANTT</b>					SEC. MSBP
Refiner Disc No. Y 6340-2 L (STATOR-01) Bldg. 12 / 05-A					GROUP M-I
BASED ON SAMPLE					DRG No. 1/0369
VETTED BY				SHT No. 01 of 04	FILING No. P/0/43 /B

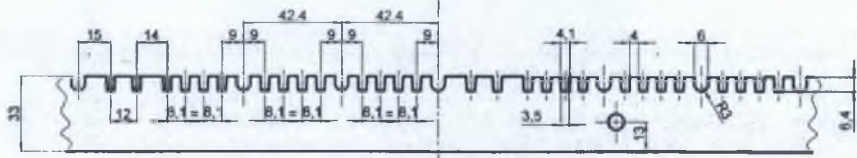
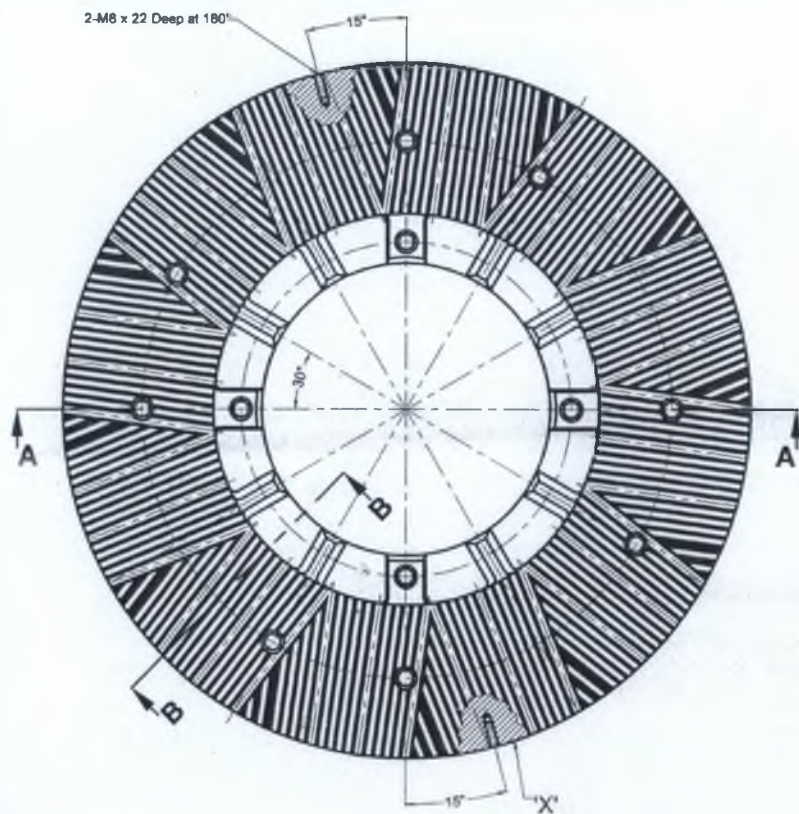

VIEW 'X'

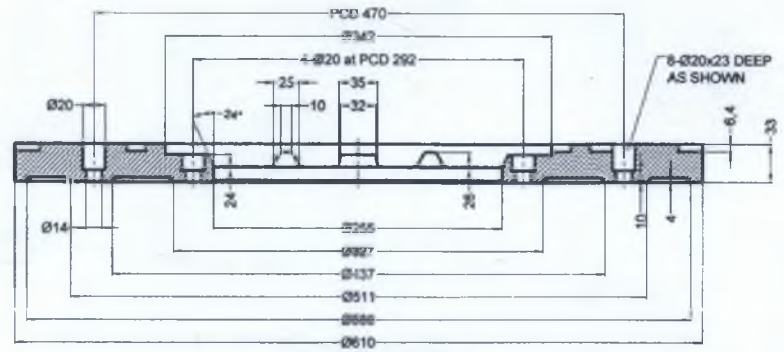

SECTION "A-A"

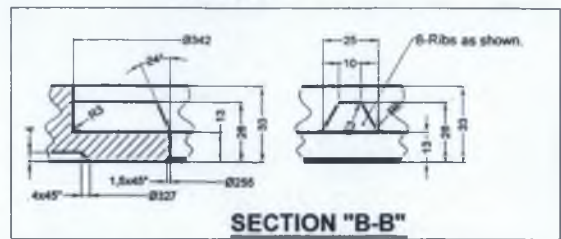

SECTION "B-B"

Note:-  
 (i) DIMENSIONS ARE IN MM  
 (ii) PERMISSIBLE MACHINING ALLOWANCE MAY BE ADDED.

**HD & TD**  
 Vicker Hardness :- 600 ±30

Material Composition Provided By User	
Si	1.03 to 1.43 %
Ni	1.04 to 1.49 %
Cr	24.25 to 26 %
Mn	0.5 to 0.55 %
Fe	Balance

Sr. #	Description	Qty.	Material.	Heat Treatment	Remarks
01	Refiner Disc No. Y6440L(ROTOR-02)	01			
DRAWN S/raam & Eshan C Man / AY0					
TRACED					
CHECKED T.O / AM- D.O.E					
APPROVED MGR-MECH & SER					
DATE 30-08-2022					
SCALE N.T.S					
AMENDMENT					SIGN.
POF HAVELIAN CANTT					SEC MSBP
REFINER DISC No. Y 6440 L (ROTOR-02) Bldg. 12 / 05-A					GROUP M-J
BASED ON SAMPLE					DRG No.
VERIFIED BY					DOE/M-0369
SHT No. 02 of 04					FILING No.
					PI 01143 / B



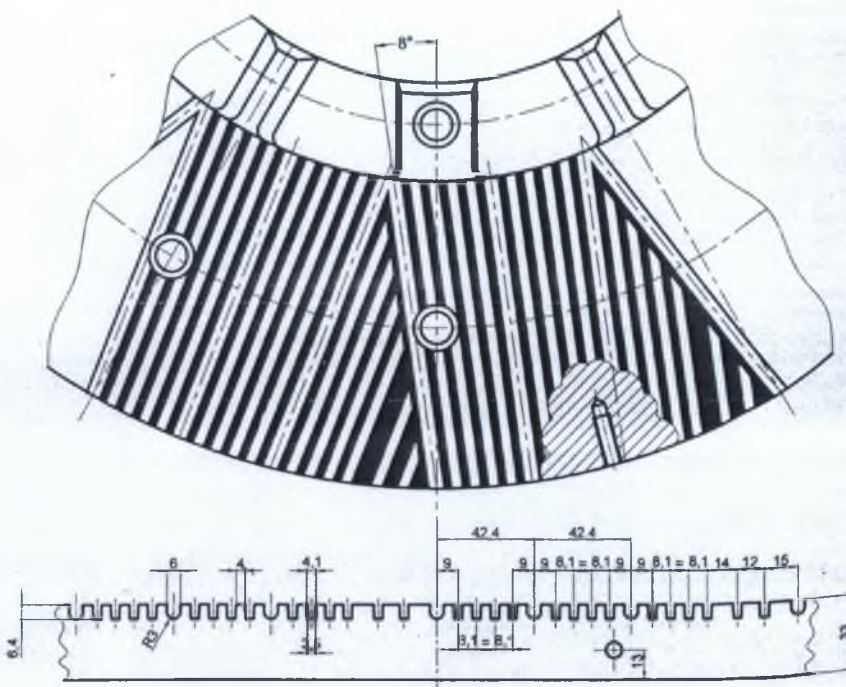
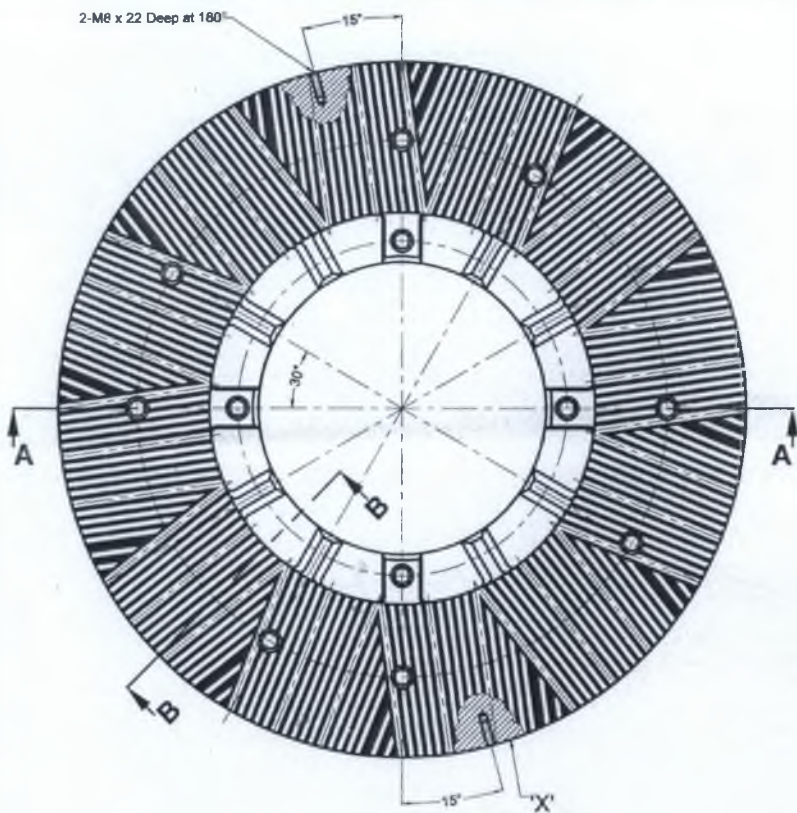

VIEW 'X'

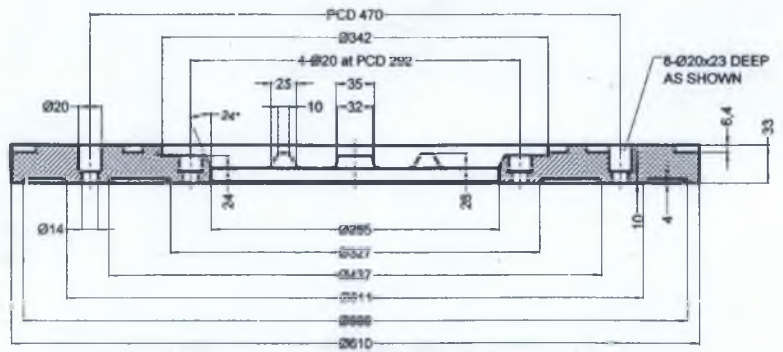

SECTION "A-A"

Note:-  
 (I) DIMENSIONS ARE IN MM  
 (II) PERMISSIBLE MACHINING ALLOWANCE MAY BE ADDED.

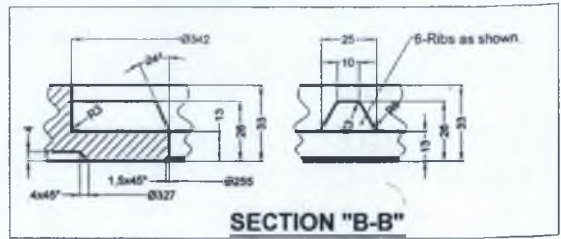
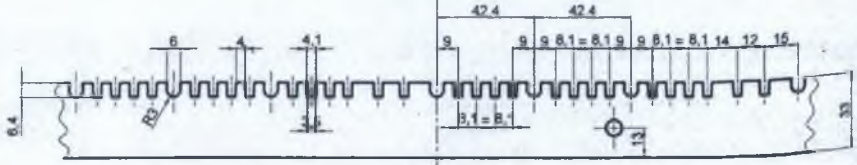

SECTION "B-B"

**HD & TD**  
 Vicker Hardness - 600 ±30

Material Composition  
 Provided By User.

Si	1.03	to	1.43	%
Ni	1.04	to	1.49	%
Cr	24.25	to	26	%
Mo	0.5	to	0.55	%
Mn	1.93			%
Fe	Balance			

01	Refiner Disc No. Y6440R(ROTOR-03)	01			
Sr. #	Description	Qty.	Material.	Heat Treatment	Remarks
	DRAWN Slasem & Ehsan C Man / ATO				
	TRACED				
	CHECKED T.O / AM - D.O.E				
	APPROVED MGR-MECH & SER				
	DATE 30-08-2022				
	SCALE N.T.S				
<b>POF HAVELIAN CANTT</b>					
REFINER DISC No. Y 6440 R (ROTOR-03) Bldg. 12 / 05-A					DRG No. 10369
BASED ON SAMPLE			SHT No. 03 of 04		FILING No. P101143 B
VETTED BY					

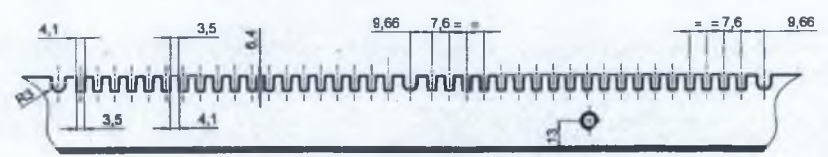
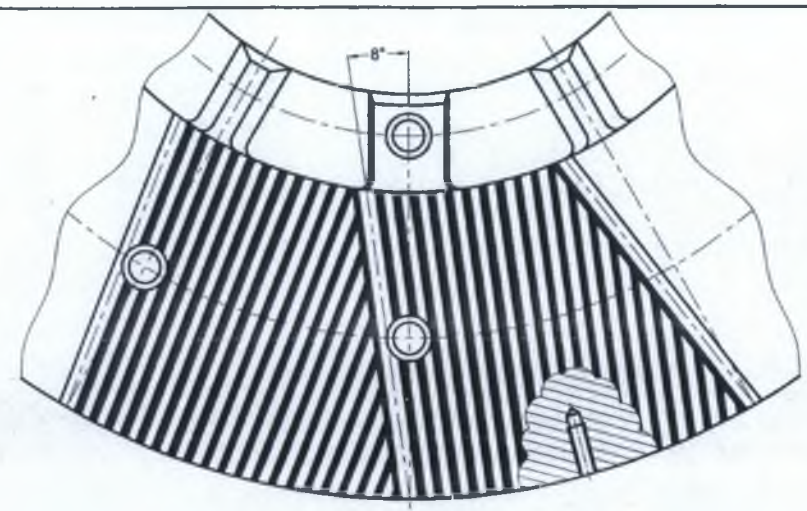
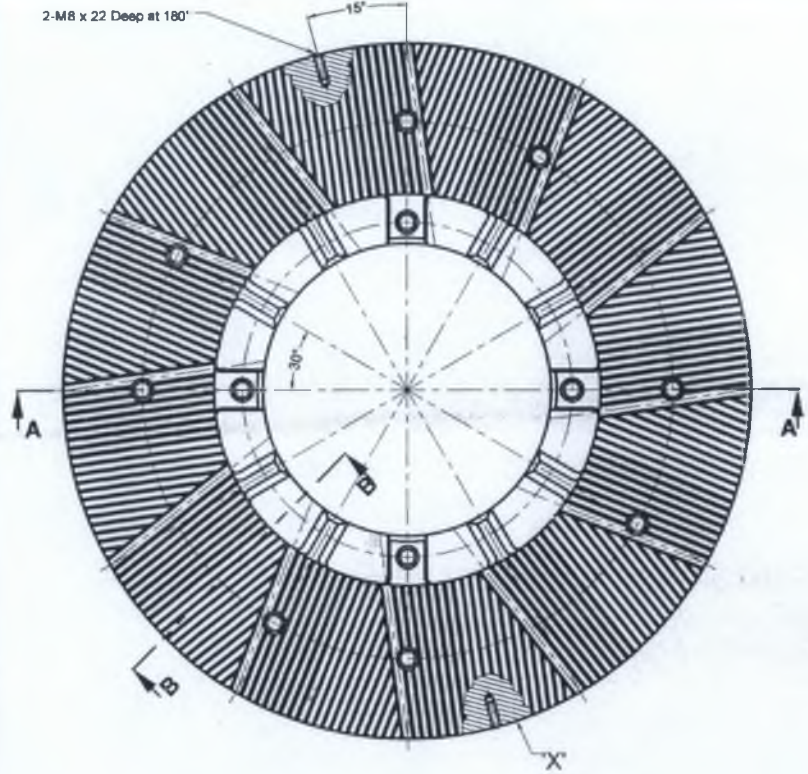

VIEW ' X '

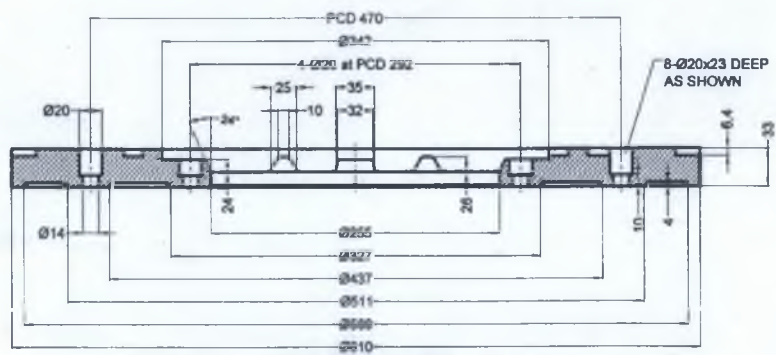

SECTION "A-A"

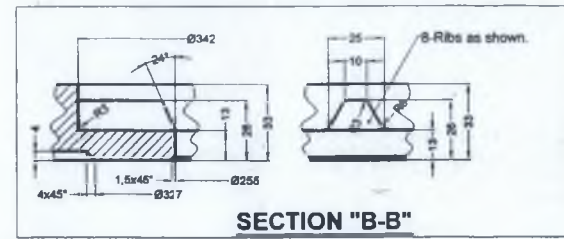

SECTION "B-B"

**HD & TD**  
Vicker Hardness :- 600 ±30

Material Composition Provided By User		
Si	1.03 to	1.43 %
Ni	1.04 to	1.49 %
Cr	24.25 to	28 %
Mo	0.5 to	0.55 %
Mn	1.93 %	
Fe	Rest	

Sr. #	Description	Qty.	Material.	Heat Treatment	Remarks
01	Refiner Disc No. Y 6340-2 R (STATOR)	01			
DRAWN Saleem & Urooj Khannaz C' Man / Skd					
TRACED					
CHECKED <i>[Signature]</i> T.O / AM- D.O.E					
APPROVED <i>[Signature]</i> MGR-MECH & SEP.					
DATE 30-08-2022					
SCALE N.T.S					
					AMENDMENT
					SIGN.
<b>POF HAVELIAN CANTT</b>					SEC MSBP
					GROUP M-I
Refiner Disc No. Y 6340-2 R (STATOR-04) Bldg. 12 / 05-A					DRG No. DOE/M-10369
BASED ON SAMPLE					FILING No. P101143 / B
VETTED BY <i>[Signature]</i>					SHT No. 04 of 04

**Note:-**  
(i) DIMENSIONS ARE IN MM  
(ii) PERMISSIBLE MACHINING ALLOWANCE MAY BE ADDED.